

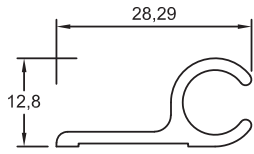

Stocked Sections

Miscellaneous & Mouldings



Section No.6595
0.237 kg/m, per 96

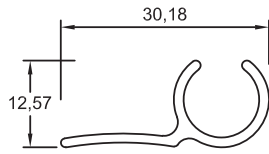

Section No.YLJ02552
0.193 kg/m, per 102

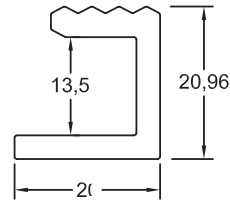

Section No.YLJ07669
0.445 kg/m, per 104

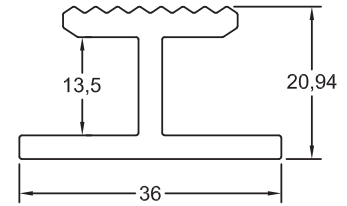

Section No.YLJ07668
0.673 kg/m, per 155

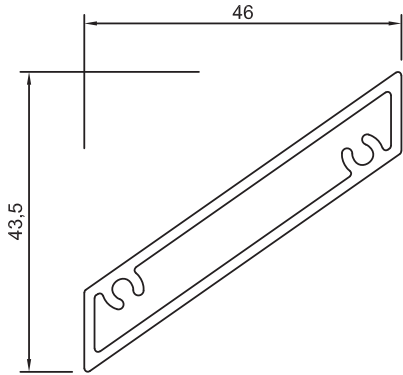

Section No.RB-452
0.594 kg/m, per 135

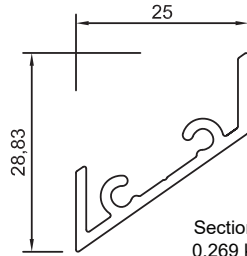

Section No.5947
0.269 kg/m, per 135



Section No.YLJ02519
Perspex Cap
0.250 kg/m, per 94

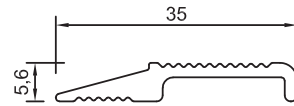

Section No.RB-706
0.234 kg/m, per 88

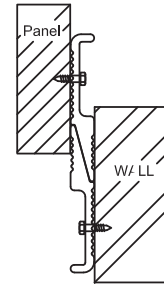

Instruction Drawing
For RB-706