

Section No. 8165
Wide Vision Rail
2.285 kg/m, Per 363

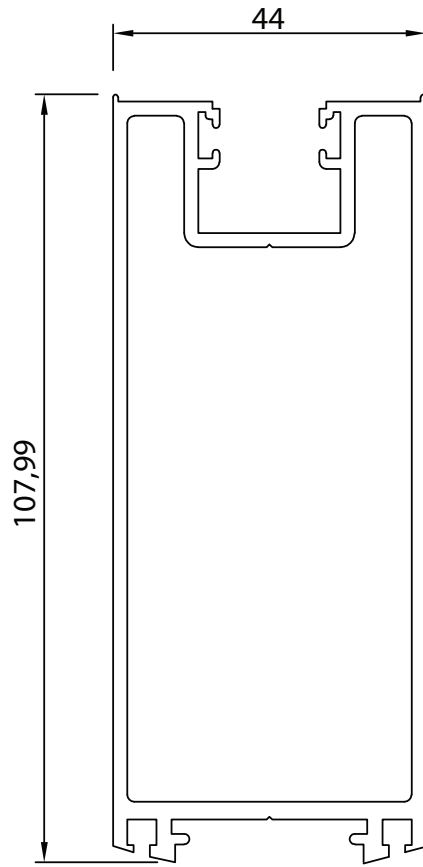

Section No. G611
Wide Lock Stile
1.998 kg/m, Per 421

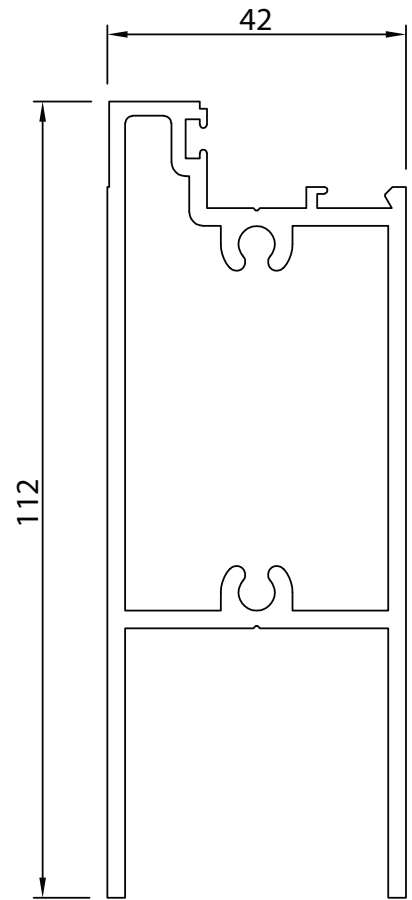

Section No. 8164
Top / Bottom Rail
2.232 kg/m, Per 410

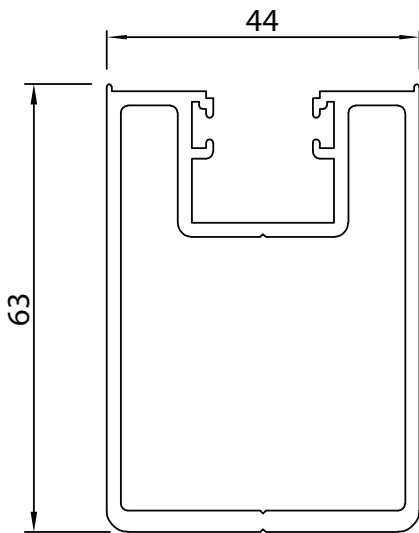

Section No. G250
Hinge Stile
1.470 kg/m, Per 286

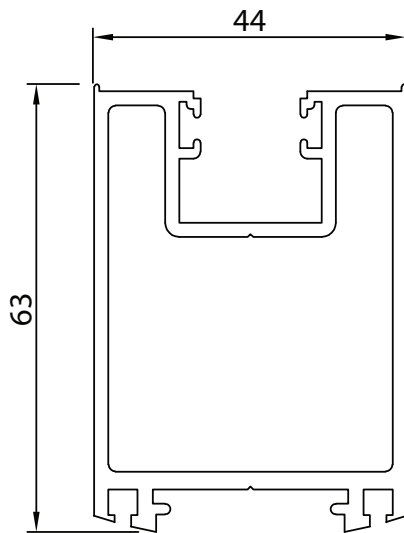

Section No. G249
Lock Stile
1.510 kg/m, Per 331

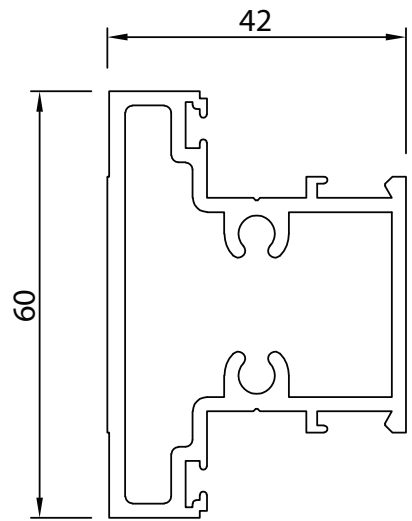

Section No. G251
Narrow Vision Rail
1.400 kg/m, Per 259

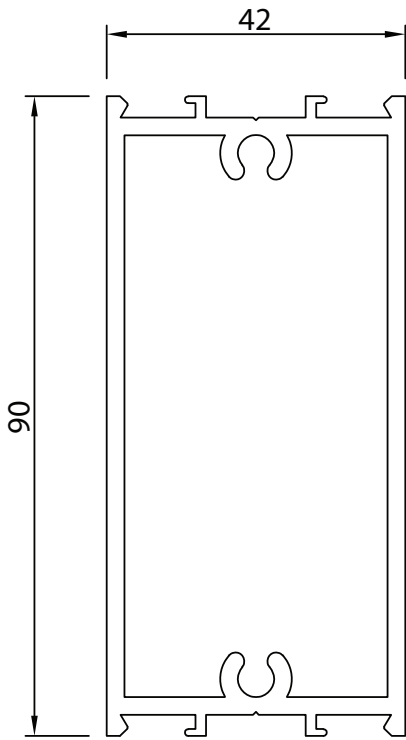

Section No.6100
Beadable Vision Rail
1.961 kg/m, Per 313

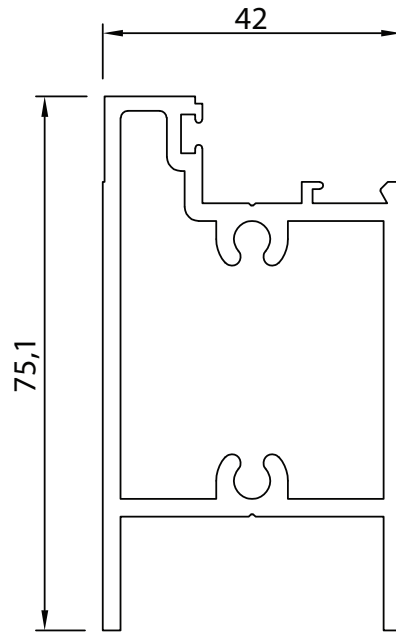

Section No.8163
Top Rail
1.732 kg/m, Per 292

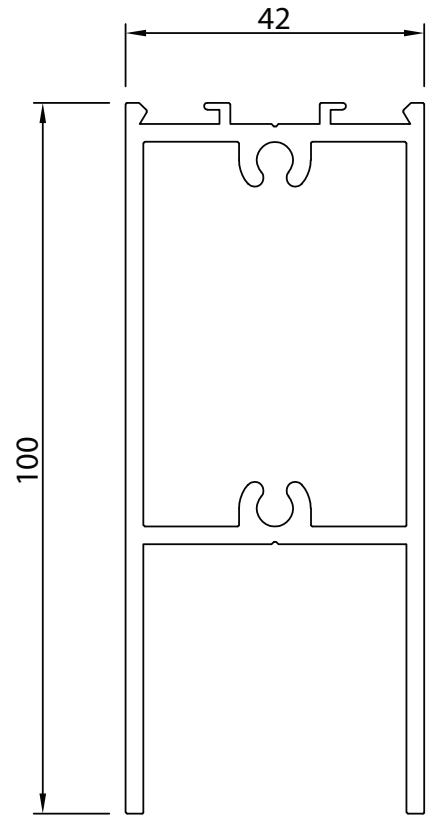

Section No.31882
Door Rail
2.072 kg/m, Per 384

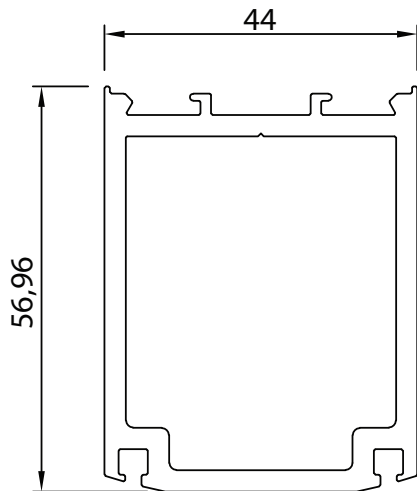

Section No.33143
Door Stile
1.626 kg/m, Per 248

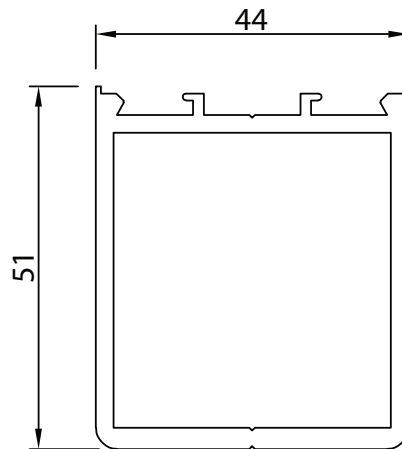

Section No.5622
Hinge Stile
1.299 kg/m, Per 215

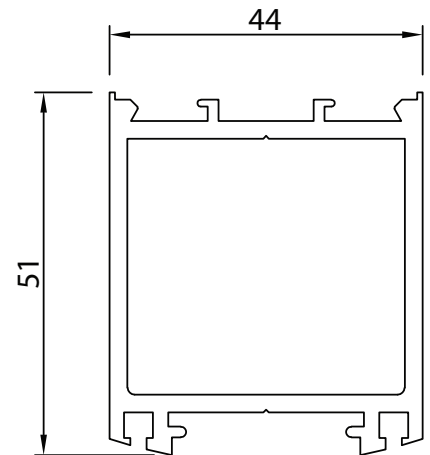

Section No.8166
Beadable Lock Stile
1.325 kg/m, Per 260

Stock in mill finish & anodised satin. Subject to stock availability at time of order.
Stock in Christchurch branch only (3 workingdays delivery).



Stocked Sections

Commercial Doors

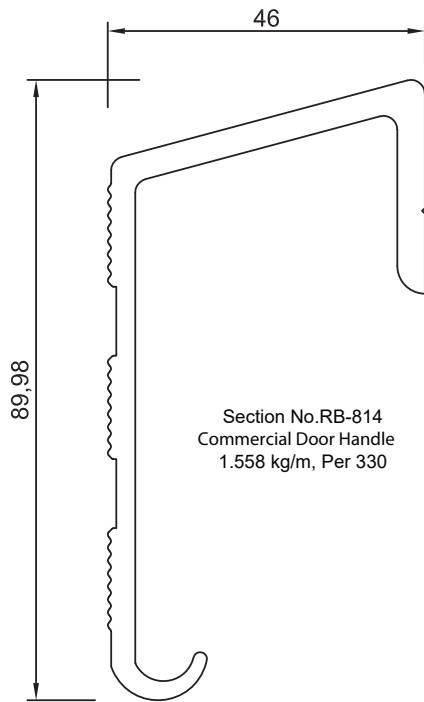

Section No. RB-814
Commercial Door Handle
1.558 kg/m, Per 330

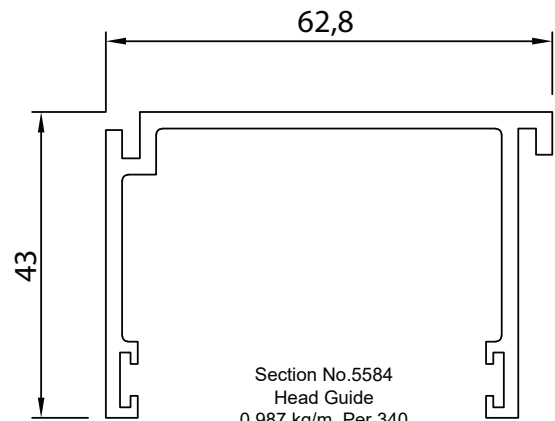

Section No. 5584
Head Guide
0.987 kg/m, Per 340

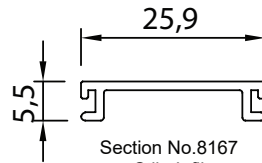

Section No. 8167
Stile Infil
0.140 kg/m, Per 85

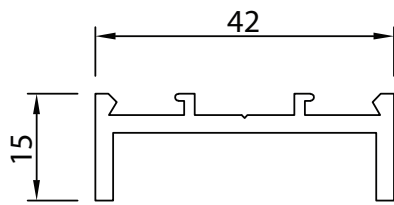

Section No. 5620
Infil Vision Rail
0.484 kg/m, Per 157

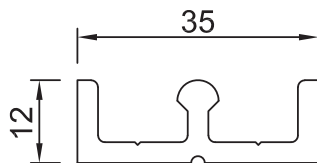

Section No. 6350
Door Track
0.518 kg/m, Per 127

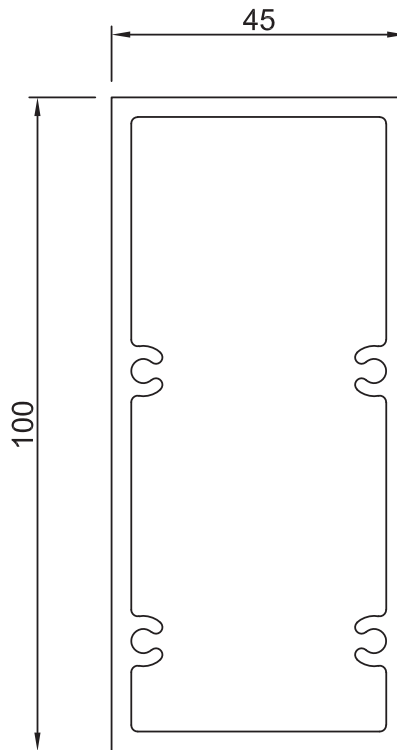

Section No. 9436
Screwports
2.478 kg/m, Per 290

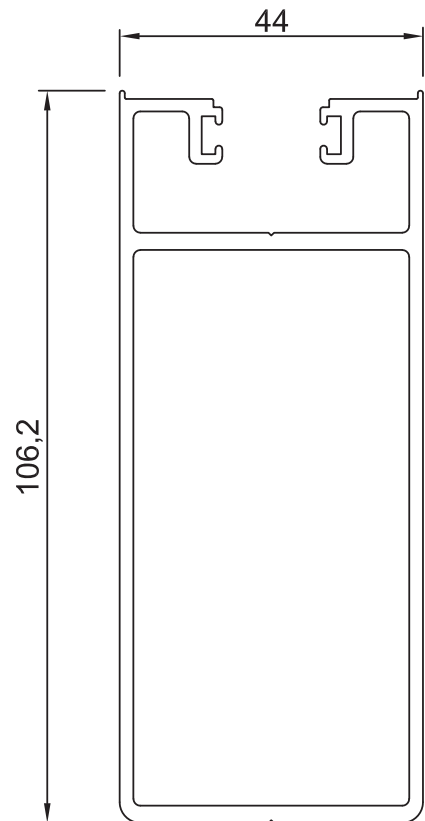

Section No. G419
Wide Hinge Stile
1.937 kg/m, Per 371

Stock in mill finish & anodised satin. Subject to stock availability at time of order.

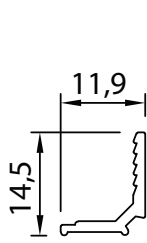

*Section No.31855
Double Glazing Door Bead
0.095 kg/m, Per 53

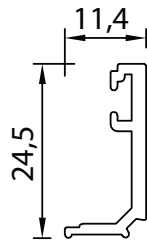

#Section No.32550
Double Glazing Door Bead
0.194 kg/m, Per 87

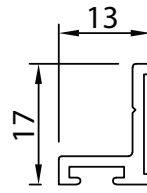

*Section No.6136
Door Stop
0.150 kg/m, Per 72

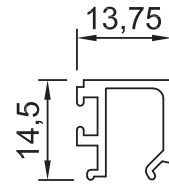

*Section No.5653
Square Bead
0.166 kg/m, Per 98

* Stock in mill finish & anodised satin. Subject to stock availability at time of order.

Stock in Christchurch branches only (3 working days delivery).