

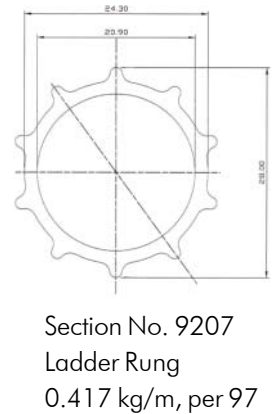

Stocked Sections

(MLD) Mouldings

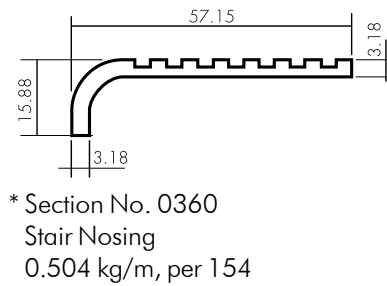
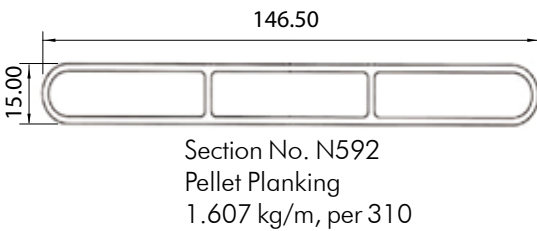
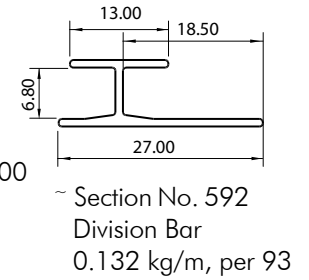
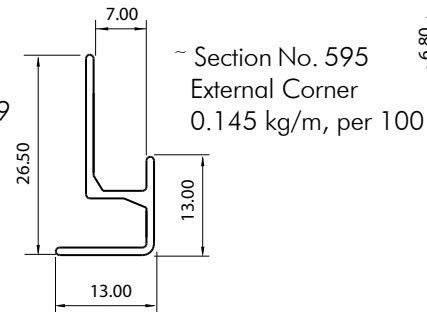
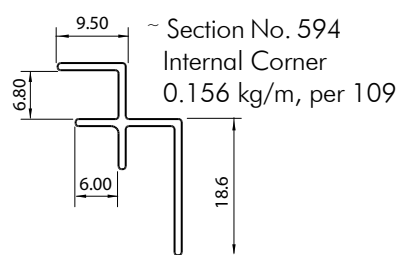
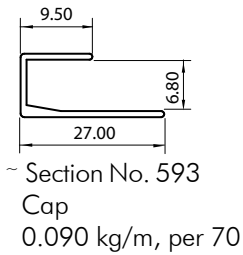
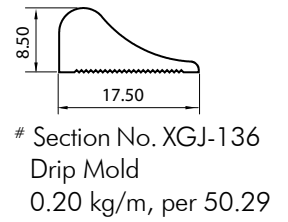
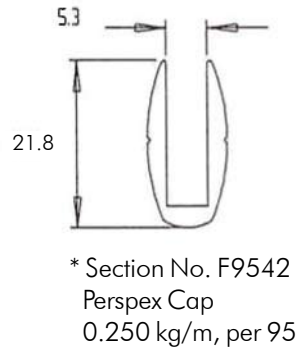
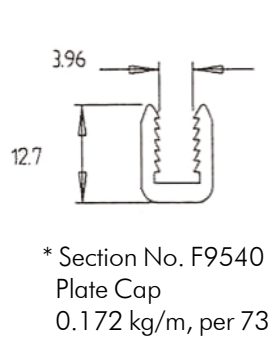
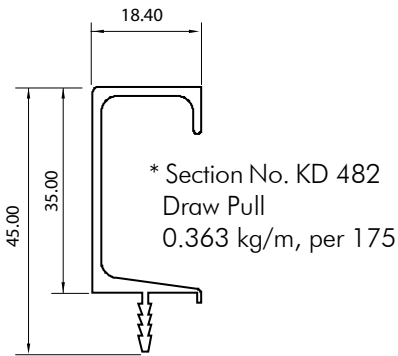

- * Stock anodised satin & mill finish
- # Supplied in bright polish & 2.25 mtr length
- ~ Supplied in 2.7 mtr length

Not to Scale